



MDX-E100

Natural Sound Minidisc Recorder

Lecteur Enregistreur Minidisc

MINIDISC RECORDER MDX-E100

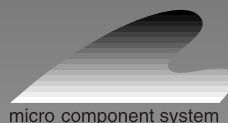

micro component system

PIANOCRAFT

**OWNER'S MANUAL
MODE D'EMPLOI
BEDIENUNGSANLEITUNG
BRUKSANVISNING
MANUALE DELL'UTENTE
MANUAL DE INSTRUCCIONES
GEBRUIKSAANWIJZING**

CAUTION: READ THIS BEFORE OPERATING YOUR UNIT.

1. This unit is a sophisticated mini disc recorder. To ensure proper operation for the best possible performance, please read this manual carefully.
2. Install your unit in a cool, dry, clean place with good ventilation. Avoid placing it in direct sunlight, near sources of heat, or in locations subject to vibration, excessive dust, heat, cold, or moisture. To avoid humming sounds, position the unit away from other electrical appliances, motors, and transformers.
3. Do not operate the unit upside-down. It may overheat, possibly causing damage.
4. Do not place another component on top of this unit, to do so may discolor or damage the surface of the unit.
5. Do not open the cabinet of this unit, to do so may result in damage to the unit or electrical shock. If any foreign object or substance gets into the unit, contact your dealer for assistance.
6. When removing the power plug from the wall outlet, always pull directly on the plug; never pull the cord itself.
7. Do not apply excessive force when operating switches and knobs.
8. When moving the unit, be sure to first disconnect the power cord from the AC outlet and disconnect all cords connecting the unit to other equipment.
9. To prevent damage by lightning, disconnect the power cord from the wall outlet during an electrical storm.
10. Do not attempt to clean this unit with chemical solvents as this may damage the finish. Use a clean, dry cloth.
11. Be sure to read the "TROUBLESHOOTING" section for advice on common operating errors before concluding that your unit is faulty.
12. Keep this manual in a safe place for future reference.
13. The voltage to be used must be the same as that specified on this unit. Using this unit with a higher voltage than that which is specified is dangerous and may result in a fire or other type of accident causing damage. YAMAHA will not be held responsible for any damage resulting from use of this unit with a voltage other than that which is specified.

Note

Please check the copyright laws in your country to record from records, compact discs, radio, etc. Recording of copyright material may infringe copyright laws.

CLASS 1 LASER PRODUCT

This mini disc recorder is classified as a CLASS 1 LASER product. The CLASS 1 LASER PRODUCT label is located on the rear exterior. (U.K. and Europe models only)

For U.K. customers

If the socket outlets in the home are not suitable for the plug supplied with this appliance, it should be cut off and an appropriate 3 pin plug fitted. For details, refer to the instructions described below.

Note: The plug severed from the mains lead must be destroyed, as a plug with bared flexible cord is hazardous if engaged in a live socket outlet.

IMPORTANT

THE WIRES IN MAINS LEAD ARE COLOURED IN ACCORDANCE WITH THE FOLLOWING CODE:

Blue: NEUTRAL
Brown: LIVE

As the colours of the wires in the mains lead of this apparatus may not correspond with the coloured markings identifying the terminals in your plug, proceed as follows: The wire which is coloured BLUE must be connected to the terminal which is marked with the letter N or coloured BLACK. The wire which is coloured BROWN must be connected to the terminal which is marked with the letter L or coloured RED.

Making sure that neither core is connected to the earth terminal of the three pin plug.

CAUTION FOR CARRYING THE UNIT

Before carrying the unit, first remove a disc from the unit, press STANDBY/ON to turn the unit off, then disconnect the AC power plug from the wall outlet.

CAUTION

Use of controls or adjustments or performance of procedures other than those specified herein may result in hazardous radiation exposure.

Voltage Selector <General model only>

The voltage selector on the rear panel of this unit must be set for your local main voltage BEFORE plugging into the AC power supply.

Voltages are 110/120/220/240 V AC, 50/60 Hz.

This unit is not disconnected from the AC power source as long as it is connected to the wall outlet, even if this unit itself is turned off. This state is called the standby mode. In this state, this unit is designed to consume a very small quantity of power.

INTRODUCTION

Thank you for purchasing this YAMAHA product. We hope it will give you many years of trouble-free enjoyment. For the best performance, read this manual carefully. It will guide you in operating your YAMAHA product.

FEATURES

- **MINI DISC Digital Audio System**
- **Digital Optical Input (2)/Output**
- **Sampling Rate Converter**
- **EDIT Function**
- **Synchronized Recording**
- **Digital Rec Level Control**

US and foreign patents licensed from Dolby Laboratories Licensing Corporation.

CONTENTS

PART DESCRIPTIONS	4	EDITING	15
FRONT PANEL	4	ERASE	16
DISPLAY	4	Disc Erase	16
REMOTE CONTROL	5	Track Erase	16
Remote Control Operation Range	5	Part Erase	16
Battery Installation	5	Disc or Track Title Erase	17
CONNECTIONS	6	MOVE	17
PLAYBACK	7	COMBINE	17
Skipping Tracks	7	DIVIDE	18
Searching	7	UNDO	18
Switching the Display	8	DISC MAINTENANCE	18
RANDOM PLAY	9	TOC WRITE	18
REPEAT PLAY	9	FRA CHECK	18
Single Track Repeat / Full Disc Repeat	9	TITLING	19
Part (A-B) Repeat	9	MD SYSTEM LIMITATIONS	20
PROGRAM PLAY	10	DISPLAY MESSAGES	21
RECORDING	11	COPY PROTECTION (SCMS)	21
Adjusting Recording Levels	12	TROUBLESHOOTING	22
Track Marking	12	SPECIFICATIONS	23
SYNCHRO RECORDING	13		
MONAURAL RECORDING	13		
MONITOR OUT	14		
PROTECTING A RECORDED MD	14		

PART DESCRIPTIONS

FRONT PANEL

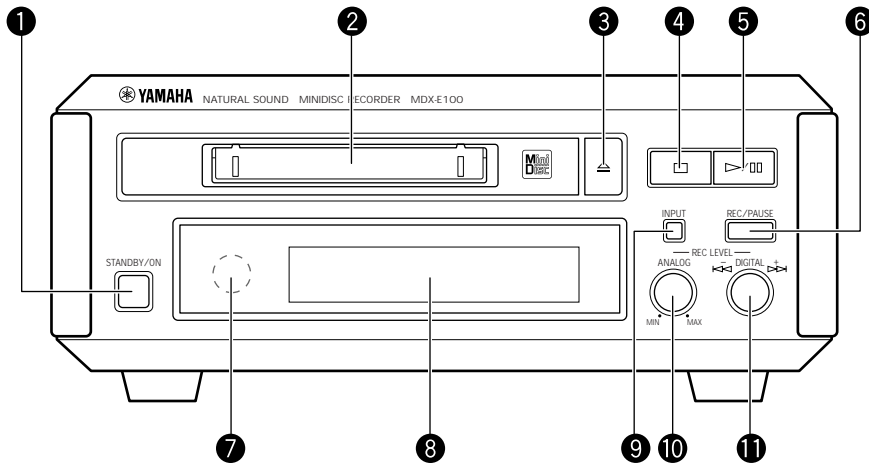

- ① **STANDBY/ON** (P.7)
- ② Disc insertion slot (P.7)
- ③ \triangle (P.7)
- ④ \square (P.7)
- ⑤ \triangleright/\parallel (P.7)
- ⑥ **REC/PAUSE** (P.11)
- ⑦ Remote control sensor (P.5)
- ⑧ Display
- ⑨ **INPUT** (P.11)
- ⑩ **ANALOG REC LEVEL** (P.12)
- ⑪ Jog dial ($\llcorner\llcorner$ $\triangleright\triangleright$)/**DIGITAL REC LEVEL** (P.7/P.12)

DISPLAY

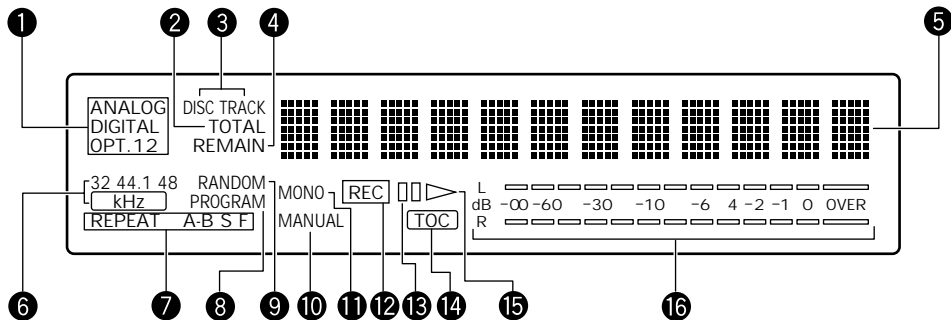

- ① Input indicator (P.11)
- ② **TOTAL** indicator (P.8)
- ③ **DISC/TRACK** indicator (P.8)
- ④ **REMAIN** indicator (P.8)
- ⑤ Multi information display
- ⑥ Sampling frequency indicator (P.11)
- ⑦ **REPEAT A-B/S/F** indicator (P.9)
- ⑧ **PROGRAM** indicator (P.10)
- ⑨ **RANDOM** indicator (P.9)
- ⑩ **MANUAL** indicator (P.12)
- ⑪ **MONO** indicator (P.13)
- ⑫ **REC** indicator (P.11)
- ⑬ Pause indicator
- ⑭ **TOC** indicator (P.15)
- ⑮ Play indicator
- ⑯ Recording level meter (P.12)

REMOTE CONTROL

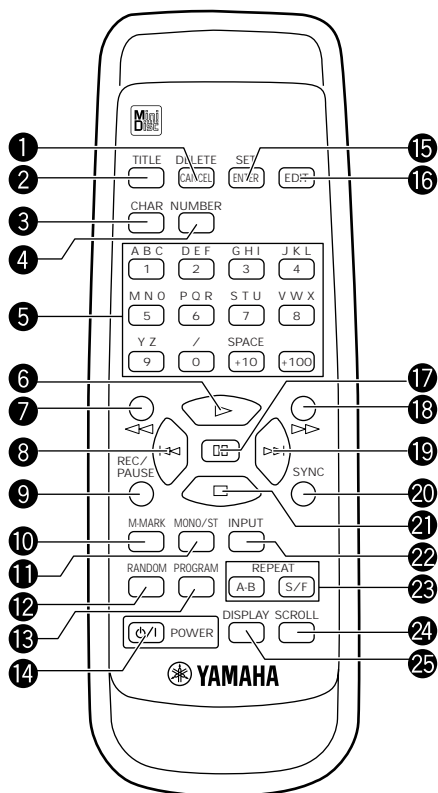

- 1 DELETE/CANCEL (P.19)
- 2 TITLE (P.19)
- 3 CHAR (P.19)
- 4 NUMBER (P.19)
- 5 Numbers [Characters] (P.7/P.19)
- 6 > (P.7/P.12)
- 7 << (P.7/P.19)
- 8 <<< (P.7/P.19)
- 9 REC/PAUSE (P.11)
- 10 M-MARK (P.12)
- 11 MONO/ST (P.13)
- 12 RANDOM (P.9)
- 13 PROGRAM (P.10)
- 14 POWER (P.7)
- 15 SET/ENTER (P.19)
- 16 EDIT (P.16)
- 17 □ (P.7)
- 18 ▷▷ (P.7/P.19)
- 19 ▷▷▷ (P.7/P.19)
- 20 SYNC (P.13)
- 21 □ (P.7)
- 22 INPUT (P.11)
- 23 REPEAT A-B (P.9)
REPEAT S/F (P.9)
- 24 SCROLL (P.8)
- 25 DISPLAY (P.8)

• You can also use the remote control supplied with the YAMAHA receiver RX-E100 to execute main operations of this unit. (Refer to the owner's manual of RX-E100/CDX-E100.)

Remote Control Operation Range

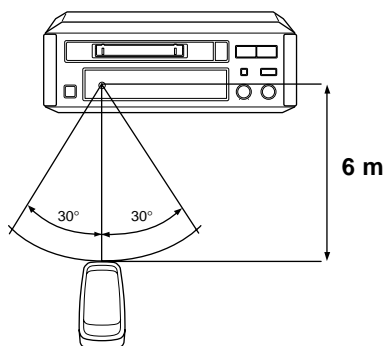

Notes

- There should be no large obstacles between the remote control and the remote sensor on the main unit.
- Strong light (especially from an inverter type fluorescent lamp) shining directly on the remote sensor may prevent proper operation. In such cases, reposition the main unit to avoid direct light.

Battery Installation

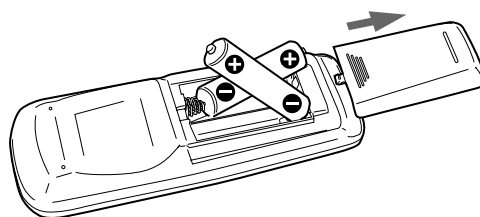

Battery replacement

When you notice a decrease in the operating range of the remote control, replace both batteries with new ones.

Notes

- Use only AA, R6, UM-3 batteries for replacement.
- Be sure to insert the batteries with correct polarity (as illustrated on the battery compartment).
- Remove the batteries if the remote control will not be used for an extended period of time.
- If batteries leak, dispose of them immediately. Avoid touching the leaking material or letting it come into contact with clothing, etc. Clean the battery compartment thoroughly before installing new batteries.

CONNECTIONS

Do not plug in this unit (or other components) until all connections are complete.

- Connections should be made to the correct input/output terminals on the other component.
- Also refer to the owner's manual supplied with the component you are connecting.
- If the placement of this unit causes noise in other equipment, such as a tuner, move them farther apart.
- The connection using the SYSTEM CONNECTOR jack allows you to control this unit as well as the connected components of YAMAHA E100 series. Make connections between the E100 series components using the system control cable.

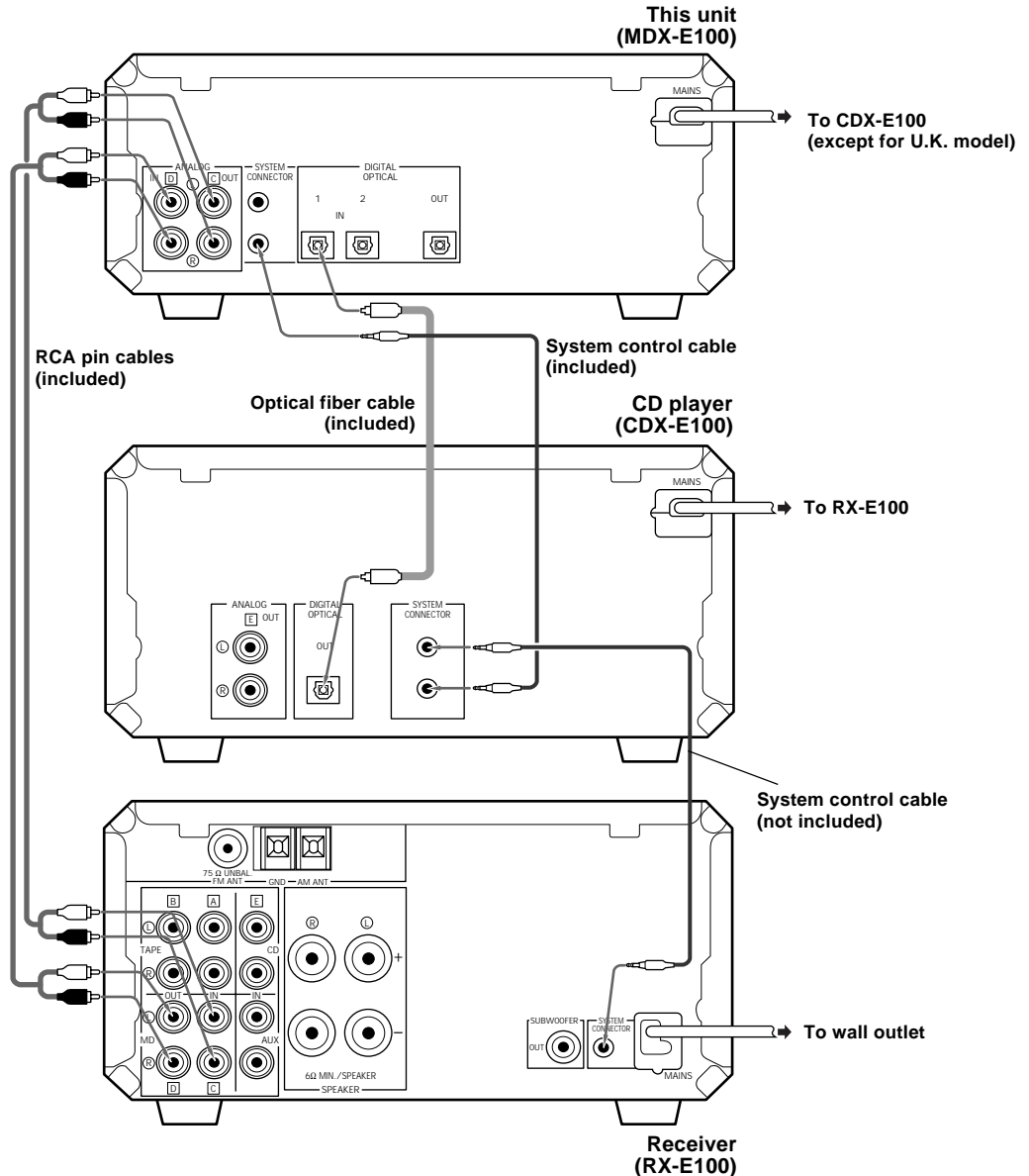

Notes

- The ANALOG OUT terminals on this unit are marked [C] and the ANALOG IN jacks are marked [D]. When connecting this unit to the YAMAHA RX-E100 receiver whose terminals are marked [A], [B], [C], [D] and [E], connect this unit's ANALOG OUT terminals to the input terminals marked [C] and connect this unit's ANALOG IN terminals to the output terminals marked [D] on the rear panel of the receiver RX-E100.
- Before making OPTICAL connections, remove the terminal cover(s).
- In order to protect the terminals from dust, be sure to attach the terminal covers when the optical terminals are not being used.
- The SYSTEM CONNECTOR jack should be connected to the SYSTEM CONNECTOR jack on the CD player CDX-E100.
- For digital recording, the DIGITAL OPTICAL 1 IN jack should be connected to the DIGITAL OPTICAL OUT jack on the CD player CDX-E100. The DIGITAL OPTICAL 2 IN jack and the DIGITAL OPTICAL OUT jack should be connected to the jacks of external digital components.

PLAYBACK

Preparations

- Press **STANDBY/ON** (**POWER** on the remote) to turn this unit on.
- Set the RX-E100 receiver to MD.

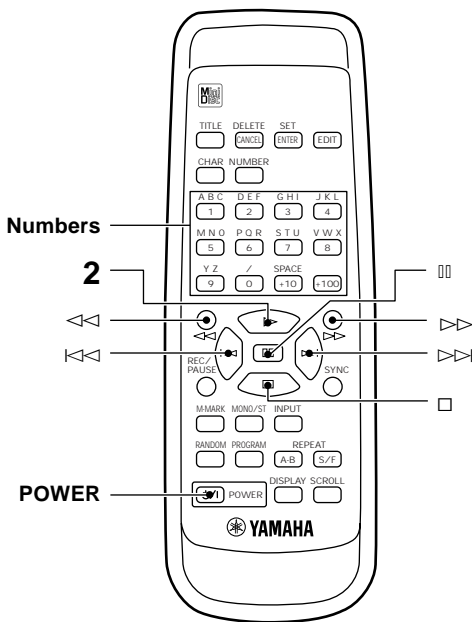
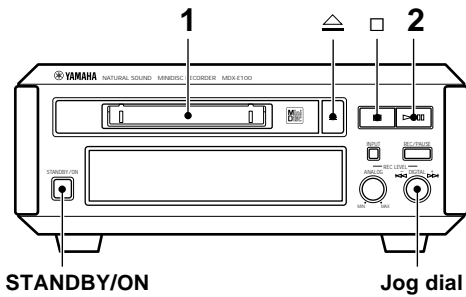

- 1 Insert an MD.

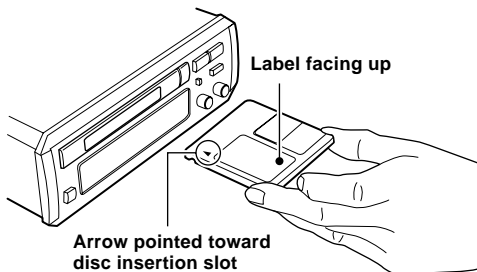

- 2 Press \triangleright/\square (\triangleright on the remote) to start playback.
- 3 Adjust the volume using the volume control on the RX-E100.

To pause

Press \triangleright/\square (\square on the remote).

Press again to resume playback (or press \triangleright on the remote).

To stop

Press \square .

To eject the MD

Press \triangle .

Skipping Tracks

To skip to the next track

Turn the jog dial to the right (or press $\triangleright|$ on the remote).

To skip to a previous track

Turn the jog dial to the left (or press $\llcorner\llcorner$ on the remote).

To skip to a specific track number

Press the number buttons on the remote corresponding to the track you desire.

Example:

To select track 3, press **3**.

To select track 13, press **+10**, then press **3**.

To select track 23, press **+10** twice, then press **3**.

To select track 123, press **+100** once, and **+10** twice, then press **3**.

Searching

To search forward during play or pause

Press and hold $\triangleright\triangleright$.

To search in reverse during play or pause

Press and hold $\llcorner\llcorner$.

Notes

- Sound can be heard when searching in play mode to help you locate the desired position within the track. No sound is heard when searching in pause mode, but the search is conducted at a higher speed.
- Search may not function correctly when there are several consecutive tracks consisting of only a few seconds each.

Switching the Display

Press **DISPLAY** during stop or playback to display other information, such as the remaining time and track titles.

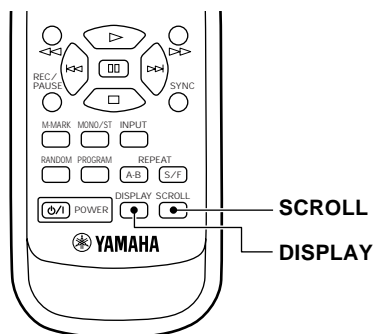

During stop

Press **DISPLAY** repeatedly to display the following information.

① Number of tracks and total playing time

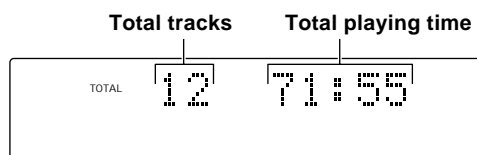

② Time remaining on the MD (only for recordable MDs)

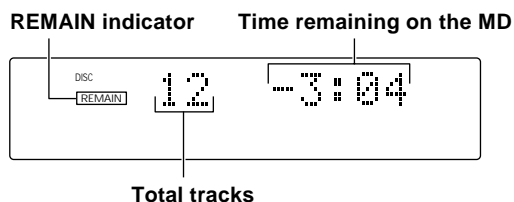

③ Disc title

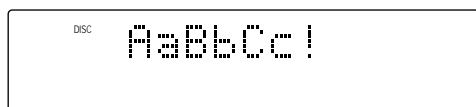

During playback

Press **DISPLAY** repeatedly to display the following information.

① Current track number and elapsed time

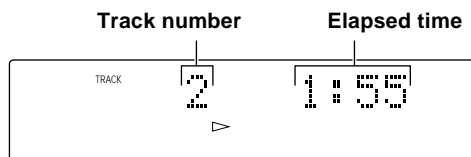

② Time remaining on the current track

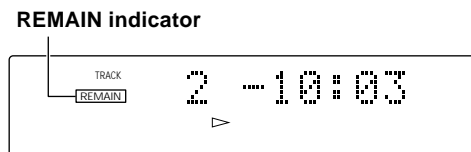

③ Track title

If the track has not been given a name, "No Title" is displayed.

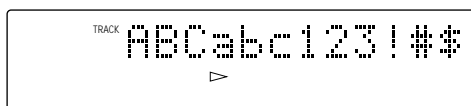

To view the entire disc (track) title

If the disc (track) title is too long to fit in the display, press **SCROLL** to move the title sequentially across the display. While the title is being displayed, press **SCROLL** to pause the display, and again to continue presentation of the title. Press and hold **SCROLL** for rapid presentation of the title.

RANDOM PLAY

You can have the unit play all the tracks on a disc in random order.

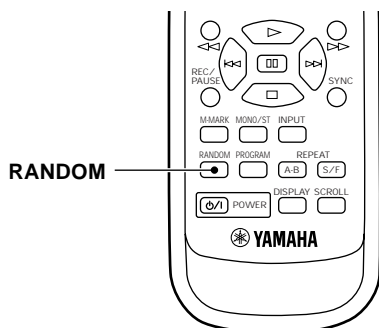

To start random playback

Press **RANDOM**.

The **RANDOM** indicator lights up and “- - - _ _ : _ _” appears in the display while the unit selects a track. Playback starts automatically.

To cancel

Press **RANDOM** again to turn off the **RANDOM** indicator or press \square .

Note

Pressing $\triangleright \triangleright$ during random play skips to another track at random. Pressing $\triangleleft \triangleleft$ returns to the beginning of the current track (you cannot return to previously played tracks).

REPEAT PLAY

You can have the unit repeat a single track, a full disc, or just part of a track.

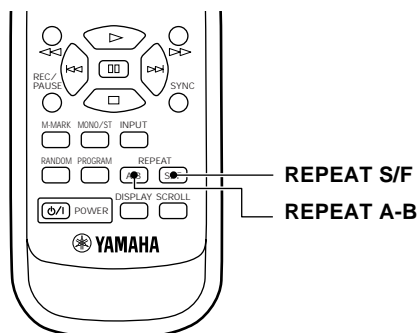

Single Track Repeat / Full Disc Repeat

Press **REPEAT S/F** repeatedly to light the **REPEAT S** or **REPEAT F** indicators.

To repeat the single track, light the **REPEAT S** indicators.



To repeat the full disc, light the **REPEAT F** indicators.



To cancel

Press **REPEAT S/F** repeatedly to turn off the **REPEAT S** or **REPEAT F** indicators.

Notes on Full Disc Repeat

- In program play mode, the entire program is played repeatedly.
- In random play mode, the unit reshuffles the tracks and plays them again after each track plays once.

Part (A-B) Repeat

This function lets you repeat a specific part of a track. It's a convenient way to study a language, or to learn the lyrics to your favorite song (etc.).

- 1 Press **REPEAT A-B** during playback to specify the beginning (A point) of the part you want to repeat. The **REPEAT A** indicators light up.



- 2 Press **REPEAT A-B** again to specify the end (B point) of the part you want to repeat. The **REPEAT A-B** indicators light up and the part you specified starts to repeat.



To cancel

Press \square or **REPEAT A-B**.

PROGRAM PLAY

This function lets you enjoy listening to your favorite tracks in any order you desire.

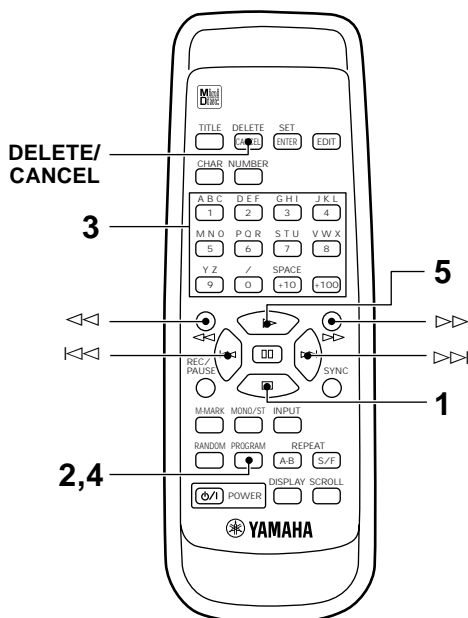

- 1 Press **PROGRAM** to stop playback.
- 2 Press **PROGRAM** to light up the PROGRAM indicator.
- 3 Program the desired track by pressing the corresponding number buttons.

Example:

To select track 3, press **3**.

To select track 13, press **+10**, then press **3**.

To select track 23, press **+10** twice, then press **3**.

To select track 123, press **+100** once, and **+10** twice, then press **3**.

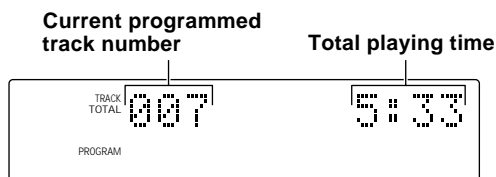

Repeat this operation to program up to 30 steps.

4 Press **PROGRAM** to confirm the program.

5 Press **▷** to start program playback.

To check the programmed data

- ① Stop or pause program playback.
- ② Press **◀◀** or **▶▶** to skip through the step information (or use the jog dial on the front panel).

To change a step

- ① Stop program playback.
- ② Press **PROGRAM**.
- ③ Press **◀◀** or **▶▶** to skip through the step information (or use the jog dial on the front panel).
- ④ Use the number buttons to program a new track number for that step. The original track is cleared from memory and the new track is programmed.

To cancel

During the stop mode, press **□** to turn off the PROGRAM indicator.

Notes

- If the total time exceeds 100 minutes, "Over" is displayed instead of the total time.
- **◀◀** or **▶▶** can be used during playback to skip between programmed tracks.

RECORDING

This unit allows you to make recordings from a wide variety of program sources (both analog and digital). When recording an analog source (such as an FM broadcast or cassette) this unit converts the analog signals to a 44.1 kHz digital signal before recording them onto the MD.

When recording a digital source, this unit converts the digital signals to 44.1 kHz for recording onto the MD. However, if you are recording a 44.1 kHz source signal (such as a CD) there is no conversion. This unit can record 32, 44.1 and 48 kHz digital signals.

Preparations

- Press **STANDBY/ON** (**POWER** on the remote) to turn this unit on.
- Set the RX-E100 to the program source to be recorded.

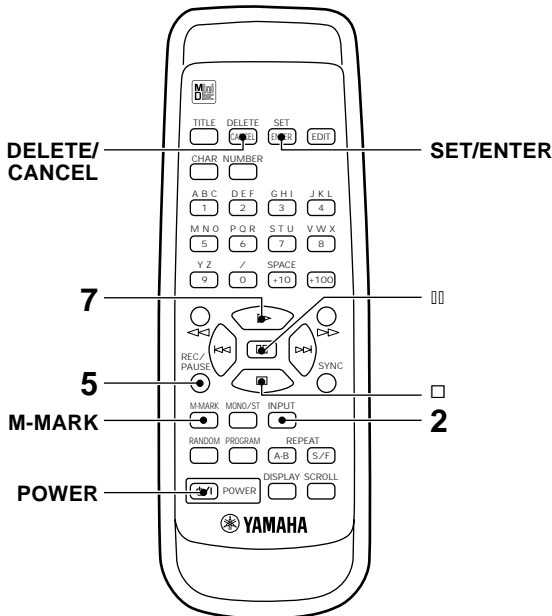
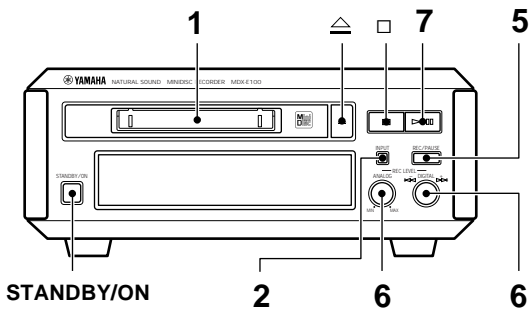

1 Insert an MD.

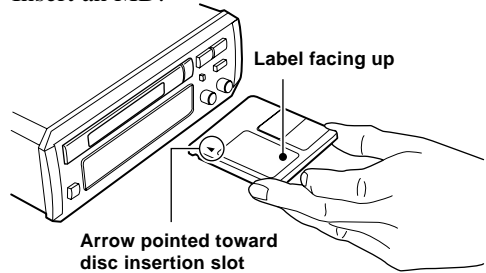

2 Press **INPUT** repeatedly to select the input you want to record.

For	Select
ANALOG IN \square	ANALOG
DIGITAL IN OPTICAL 1	DIGITAL OPT. 1
DIGITAL IN OPTICAL 2	DIGITAL OPT. 2

Input indicator

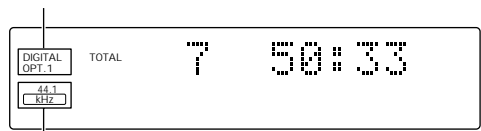

(Source) sampling frequency indicators*

* Appears when digital signal is input.

3 Locate the point where you want to start recording.

- **When recording on a blank MD**
Skip this step.
- **To start recording from the end of a previous recording**
Press \square to set this unit to stop mode.
- **To record over a previous recording**
Turn the jog dial (or press \lll or \ggg on the remote) to select a track (recording starts from the beginning of the deleted track).

4 Start playing the source to be recorded.

If you do not need to adjust the recording level, this step is not necessary.

5 Press **REC/PAUSE** to set this unit to record pause mode.

The REC \square indicators light up. "REC Standby" and the amount of time available for recording flash alternately in the display.

If you selected a track number (in step 3) to record over a previous recording

"OverWrite OK?" appears in the display. To confirm, press **SET/ENTER**. This operation will erase the selected track number (or point) and all subsequent material.

To cancel, press **DELETE/CANCEL** (or \square).

Continued on next page

SYNCHRO RECORDING

The synchronized recording function lets you set this unit to start recording automatically when a sound signal is input.

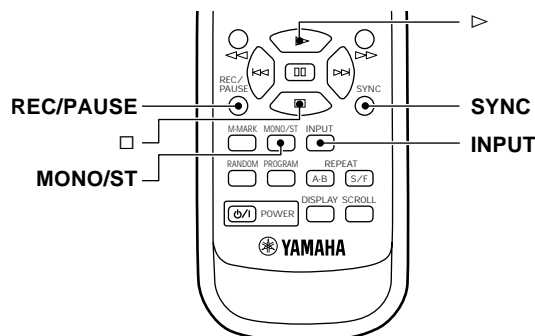

- 1 Load the sound source into the source component.
If necessary, program, or select the track you want to start recording from before proceeding to the next step. (Refer to the operation manual supplied with the source component for instructions regarding its use.)
- 2 Press **INPUT** repeatedly to select the input connected to the sound source you want to record.
- 3 Press **SYNC** to set this unit to record pause mode.
The REC indicators light up.
“Synchro REC” and the amount of time available for recording flash alternately in the display.
During synchronized recording, analog input sources are recorded at the current **ANALOG REC LEVEL** setting, digital sources are recorded at the 0 dB level.

The MD starts recording automatically when a sound signal is input. When the sound signal stops, the unit switches back to record pause mode and “Synchro REC” blinks in the display. The next time a sound signal is detected, recording starts again. In this manner, the presence of a sound signal automatically switches the unit between record and record pause modes.
- 4 Start playing the sound source.

To cancel the synchronized recording mode

Press .

Note

When the signals at the beginning of a track are lower than the level required to start synchronized recording, they are not recorded. Should this occur, perform manual recording.

MONAURAL RECORDING

Recording in monaural (mono) allows you to record up to 148 minutes of sound on one 74 minute MD.

- 1 Follow steps 1, 2, and 3, of the recording procedure described on page 11.
- 2 Press **MONO/ST** to light the MONO indicator.
- 3 Press **REC/PAUSE**.
The REC indicators light up.
“REC Standby” and the amount of time available for recording flash alternately in the display.
To adjust the recording level of digital or analog input sources, see “Adjusting Recording Levels” on page 12.
- 4 Press **▷** to start recording.

MONITOR OUT

When a disc is not loaded, you can use the monitor out function to monitor the sound of the input source.

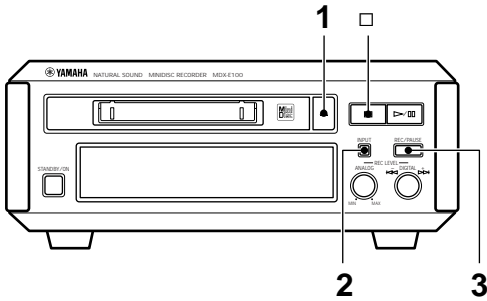

- 1 Press \square to remove the disc.
- 2 Press **INPUT** repeatedly to select the input connected to the sound source you want to monitor.
- 3 Press **REC/PAUSE**.
“Monitor Out” appears in the display.
Sound from the selected input will be output from this unit’s analog and digital output terminals.
- 4 Start playing the sound source.
The sound is output from the MD recorder’s analog and digital output terminals.

To cancel

Press \square .

Notes

- This function is useful to monitor the sound of an external digital component connected to the DIGITAL OPTICAL 2 IN jack.
- The digital volume can be adjusted when using the monitor out function. However, please note that the digital volume setting is restored to the default (0 dB) the next time a recording is made.

PROTECTING A RECORDED MD

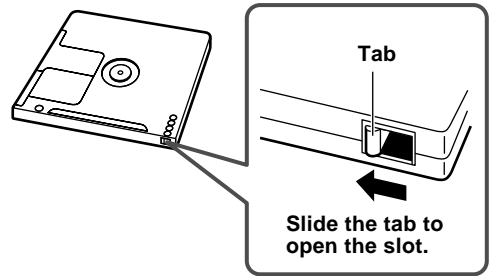

- To protect a recorded MD, slide the tab on the side of the MD to open the slot.
In this position, the MD cannot be used for recording, editing, or titling. To record, edit, or title the MD, slide the tab to close the slot.
- If the MD is protected against erasure, “Protected” appears in the display.

One of the main advantages of MD is its editing capabilities. You can remove the commercials from a radio broadcast, reorder songs into the order you want, remove songs, combine songs, and even remove part of a song.

This unit offers the following editing operations.

- **ERASE**

Lets you erase a track, the entire disc, or part of a track. You can also erase the title of a disc, or the titles of tracks on a disc.

- **MOVE**

Lets you move a track to a different track number.

- **COMBINE**

Lets you combine two adjacent tracks.

- **DIVIDE**

Lets you split a single track into two different tracks.

- **FRA CHECK**

Lets you recover disc space that may have been lost after multiple edit operations.

- **TOC WRITE**

Lets you write TOC information to the disc so that changes are saved.

- **UNDO**

Lets you undo the previous edit operation if you make a mistake.

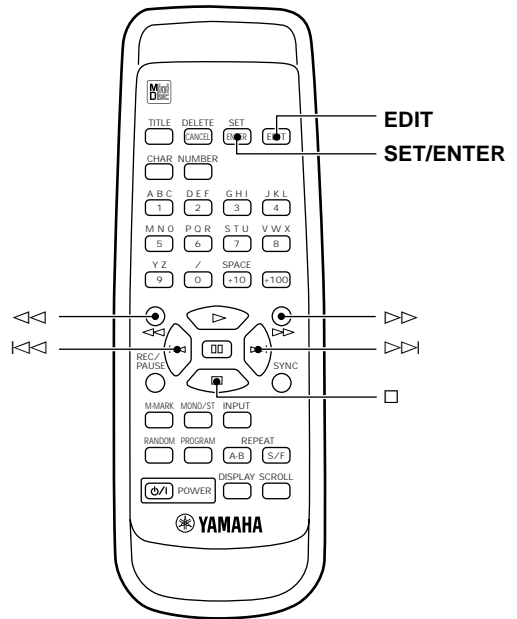

Notes on editing

- **To cancel an edit**

Press □.

- **Before editing**

Make sure that the MD is not protected against erasure. If the MD is protected, you cannot edit the MD. Slide the tab to close the slot on the side of the MD.

- **After editing**

- Press in order to update the TOC information and pull the MD out.
- The TOC indicator lights to show that the TOC information has not yet been written to the disc. Undo is possible only when the TOC indicator is lit.

ERASE

The ability to erase sound without having to re-record is a convenient function of MD. You can erase the entire disc, a single track, or just part of a track.

Disc Erase

This operation lets you erase all audio and title (character) data to create a blank MD. Please note that once erased, this data can be recovered using the UNDO function.

- 1 Press \square to set this unit to stop mode.
- 2 Press **EDIT** repeatedly to display “Disc Erase?”, then press **SET/ENTER**.
“DiscEraseOK?” appears in the display.
- 3 Press **SET/ENTER** again.
When all audio, name and title data has been erased “Complete” appears momentarily.

Track Erase

This operation lets you erase a single track as well as corresponding title data. After you erase the track, the total number of tracks decreases by one and all tracks following that track are renumbered.

Example: Erasing track 3

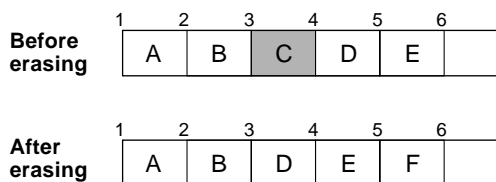

- 1 Use \llcorner or \lrcorner to select the track you want to erase.
- 2 Press **EDIT** repeatedly to display “Erase ?”, then press **SET/ENTER**.
“(track number) Erase OK?” appears in the display.
- 3 Press **SET/ENTER** again.
The track is erased and “Complete” appears momentarily.

If you plan to erase two or more tracks

To avoid confusion you should always erase from higher track numbers to lower track numbers. This prevents accidental renumbering of tracks you plan to erase.

Part Erase

This operation lets you erase part of a track.

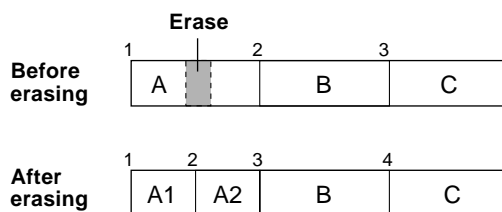

- 1 Play the track containing the part you want to erase.
- 2 Use \llcorner or \lrcorner to locate the beginning of the part you want to erase (point A), then press \square to pause at that point.
- 3 Press **EDIT** repeatedly to display “A-B Erase?”, then press **SET/ENTER**.
Point A (from step 2) is registered and “Erase A-” appears in the display.
- 4 Use \triangleright and $\triangleright\triangleright$ to locate the end of the part you want to erase (point B).
- 5 Press **SET/ENTER** to register point B.
“Check” appears, then the part you specified plays repeatedly and “Erase A-B?” appears in the display.

To adjust points A and B

Press **EDIT** repeatedly to display “A point” and “B point” alternately. Adjust the selected point by using \llcorner or \lrcorner in the direction you want to move the point.
Each point can be adjusted up to 2 seconds in either direction.

- 6 Press **SET/ENTER** again.
The part is erased and “Complete” appears momentarily.

Notes

- After part erase, a new track number is automatically assigned to the section starting after point B.
- Point B cannot be positioned before point A.

Disc or Track Title Erase

This operation lets you erase the title of the disc or the title of tracks on a disc. The title of the disc can only be erased during the stop mode, however, the title of the track can be erased during play or stop mode.

To erase a disc title

- 1 Press \square to set this unit to stop mode.
- 2 Press **EDIT** repeatedly to display “Title Erase?”, then press **SET/ENTER**.
“Disc Title” and “Erase OK?” appear alternatively in the display.
- 3 Press **SET/ENTER** again.
The disc title is erased and “Complete” appears momentarily.

To erase a track title

- 1 Use \lll or \ggg to select the track with the title you want to erase.
- 2 Press **EDIT** repeatedly to display “Title Erase?”, then press **SET/ENTER**.
“Track Title” and “Erase OK?” appear alternatively in the display.
- 3 Press **SET/ENTER** again.
The track title is erased and “Complete” appears momentarily.

Notes

- Note that the DISC and TRACK indicators appear in the display when “Title Erase” is displayed to distinguish between the two operations.
- To avoid mistakes when erasing the disc or track names, press DISPLAY repeatedly until the title display screen appears so that titles can be confirmed beforehand.

MOVE

This function lets you change the position of any track. When you move tracks, all tracks are automatically renumbered.

Example: Moving track 2 to the track number 4

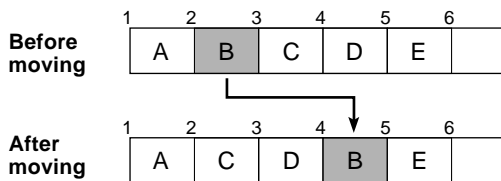

- 1 Use \lll or \ggg to select the track you want to move.
- 2 Press **EDIT** repeatedly to display “Move?”, then press **SET/ENTER**.
- 3 Use \lll or \ggg to select the track’s destination (new track number).

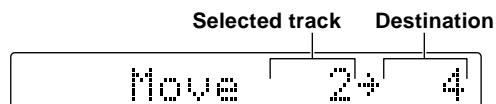

- 4 Press **SET/ENTER**.
“Complete” appears momentarily in the display.

COMBINE

This function lets you combine two consecutive tracks into one. After you combine the tracks, the total number of tracks decreases by one and the tracks following the combined tracks are renumbered.

Example: Combining tracks 2 and 3

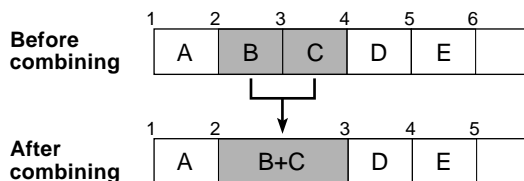

- 1 Press \square to stop playback.
- 2 Use \lll or \ggg to select the second track of the two you want to combine.
- 3 Press **EDIT** repeatedly to display “Combine?”, then press **SET/ENTER**.
“Check” appears momentarily, then the MD recorder plays the 4 seconds before and after the point where the tracks will be connected. “(track number) + (track number) OK?” appears in the display.
- 4 Press **SET/ENTER** again.
The tracks are combined and “Complete” appears momentarily.

DIVIDE

This function lets you divide one track into two separate tracks by adding a new track number to a specified point in the track.

Example: Dividing track 3

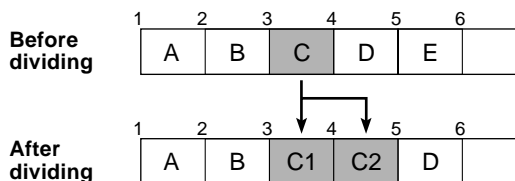

- 1 Play the track you want to divide.
- 2 Use ◀◀ or ▶▶ to locate the point where you want to divide the track, then press ⏸ to pause at that position.
- 3 Press **EDIT** repeatedly to display “Divide ?”, then press **SET/ENTER**. “Check” appears momentarily, then “Divide OK ?” appears and the MD recorder starts repeating the point where the track will be divided.
- 4 If necessary, use ◀◀ or ▶▶ to adjust the position of the point where the track will be divided.
The dividing position can be adjusted up to 2 second (255 steps) in either direction.
- 5 Press **SET/ENTER**.
The track is divided and “Complete” appears momentarily.

UNDO

The UNDO function lets you immediately return to the condition before an edit is made (note: you cannot undo an edit once you press any other button).

- ① Press ◻ to stop the MD recorder.
 - ② Press **EDIT** repeatedly to display “Undo ____”¹, then press **SET/ENTER**. “Undo OK ?” appears in the display. To cancel undoing, press ◻.
 - ③ Press **SET/ENTER** again to undo.
- ¹: The name of editing you can undo is displayed here.

Note

You cannot undo an edit once it has been written to the TOC.

DISC MAINTENANCE

This unit features two disc maintenance functions which optimize performance of your MD discs. The TOC WRITE function allows you to write any edits to the TOC without having to eject the disc. The FRA CHECK function recovers recordable space on a disc that may have been lost because of multiple edit operations.

TOC WRITE

When making a recording, the TOC (Table Of Contents) of the MD is written as soon as recording is finished. When making disc edits or titling, however, the TOC isn't automatically written unless the disc is ejected. If the unit is accidentally turned off before writing edits or titling to the TOC, it is possible that these changes will not be saved. By using this function, you can ensure that your edits or titles are saved on the disc.

- 1 Press ◻ to stop playback.
- 2 Press **EDIT** repeatedly to display “TOC Write ?”, then press **SET/ENTER**. “TOC Write OK ?” appears.
- 3 Press **SET/ENTER**. “TOC Writing” blinks in the display momentarily.

Note

The TOC Write function can only be selected when the TOC indicator is lit in the display.

FRA CHECK

When edit functions such as “MOVE” and “DIVIDE” are performed, spaces of recordable space may be lost and “TOC Full” may appear in the display to indicate that no more recording can be performed. When this occurs, it may be possible to recover the FRA (Freely Recordable Area) on the disc that was lost during edit functions so that more recording is possible.

- 1 Press ◻ to stop playback.
- 2 Press **EDIT** repeatedly to display “FRA Check ?”, then press **SET/ENTER**. “FRA Check OK ?” appears.
- 3 Press **SET/ENTER**. “Complete” appears momentarily.

This function lets you title recorded MDs and the individual tracks. Titles may consist of uppercase and lowercase letters, numbers, and symbols for a maximum of up to 250 characters for each title.

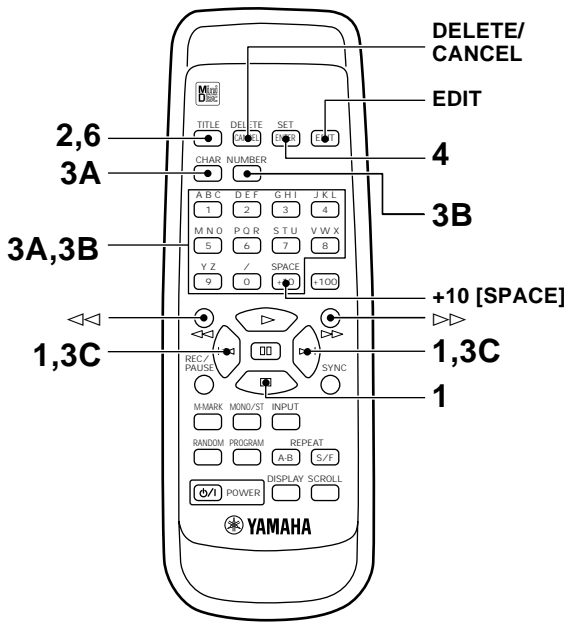

1 To title a disc

Press \square to stop playback.

To title a track

- ① Press \square to stop playback.
- ② Use \lll or \ggg to select the track you want to title. You can also title during playback, pause, or recording. However, UNDO is not possible in these cases.

2 Press **TITLE** to activate the title mode.

The cursor appears in the display.

3 A) To enter letters of the alphabet

- ① Press **CHAR** repeatedly to select between uppercase letters (A, B, C...) and lowercase letters (a, b, c...).
- ② Use the numbers [characters] buttons to select a letter.

B) To enter numbers

- ① Press **NUMBER**.
- ② Use the numbers [characters] buttons to select a number.

C) To enter symbols (! # \$ % &...)

Use \lll or \ggg to select a symbol. Symbols are between numbers and uppercase letters in the character set.

Example:

- **Having pressed CHAR in step 3:**
Press **1 [ABC]** once to select "A".
Press **1 [ABC]** twice to select "B".
- **Having pressed NUMBER in step 3:**
Press **1 [ABC]** to select "1".
- **To search symbols quickly:**
Having pressed **CHAR** and **1 [ABC]** to select uppercase "A", press \lll to search symbols from the end.

Also, you can use \lll or \ggg repeatedly to scroll through the entire character set.

4 Press **SET/ENTER** to enter the character.

Note

When a number is selected using a number button in step 3, it is not necessary to press **SET/ENTER**.

5 Repeat steps 3 and 4 to complete your title.

To delete a character (ABCD → ABD)

- ① Use \lll or \ggg to move the cursor to the position of the character you want to delete.
- ② Press **DELETE/CANCEL**.

To insert a character (ABCD → AB \square CD)

- ① Use \lll or \ggg to move the cursor to the position where you want to insert the character.
- ② Use **CHAR** or character buttons to select the new character.
- ③ Press **SET/ENTER** to set the character. The character previously in that position automatically moves to the right.

To insert a space (ABCD → AB \square CD)

- ① Use \lll or \ggg to move the cursor to the position where you want to insert the space.
- ② Press **+10 [SPACE]** on the remote.

To cancel titling

Press \square .

6 Press **TITLE** to exit the title mode.

If a title consists of more than 12 characters, it will scroll across the display once and then be displayed in abbreviated form (first 12 characters only).

To undo TITLE

- ① Press \square to display the total tracks and total playing time on the disc.
- ② Press **EDIT** repeatedly to display "Undo Title", then press **SET/ENTER**.
"Undo OK ?" appears in the display.
- ③ Press **SET/ENTER** again to undo.

7 If the TOC indicator is lit, perform the TOC WRITE function.

To perform the TOC WRITE function

- ① Follow the procedure of "TOC WRITE" on page 18.
- ② Press \triangle on the front panel. (The MD recorder automatically performs the TOC WRITE function.)

MD SYSTEM LIMITATIONS

The recording system in your MD recorder is radically different from those used in cassette and DAT decks and is characterized by the limitations described below.

Note, however, that these limitations are inherent to the MD recording system and are not a result of mechanical trouble.

“Can’t REC!” is displayed before the maximum recording time (60 or 74 minutes) has been reached

Once 255 tracks have been recorded on one MD, “Can’t REC” is displayed regardless of the total recorded time.

“TOC Full” is displayed before the maximum number of tracks (255) have been recorded

During automatic track marking, fluctuations in emphasis within songs may be interpreted as song intervals, increasing the total number of tracks and causing “TOC Full” to be displayed.

The remaining recording time does not increase even after erasing numerous short tracks

Tracks under 12 seconds in length are not counted and so erasing them may not lead to an increase in the recording time.

“TOC Reading” is displayed continuously

The “TOC Reading” display lasts longer than normal when a brand new (blank) disc is inserted.

The total recorded time and the remaining time on the MD do not total to the maximum recording time

- Recording is done in minimum units of 2 seconds each, no matter how short the material.
- This unit displays the length of the largest continuous blank area as the remaining time. Therefore, if there are several separate blank spaces, the remaining time will only display a time equivalent to the largest continuous blank space.

Tracks created through editing may exhibit sound dropout during search operations.

Track numbers are not recorded correctly

Incorrect assignment or recording of track numbers may result when CD tracks are divided into several smaller tracks during digital recording.

It is not possible to erase part of a track using the A-B ERASE function

This unit organizes the audio data in sound groups and clusters. The minimum size of these units may not consist of less than 10 seconds of stereo sound.

Limitations when recording over an existing track

- The correct remaining recording time may not be displayed.
- You may find it impossible to record over a track if that track has been recorded over several times already. If this happens, erase the track using the ERASE function.
- The remaining recording time may be shortened out of proportion to the total recorded time.
- Recording over a track to eliminate noise is not recommended since this may shorten the duration of the track.
- You may find it impossible to label a track while recording over another track.

The correct recorded/playing time may not be displayed during playback of MDs recorded in monaural.

DISPLAY MESSAGES

Can't copy

Digital recording cannot be performed. (See "COPY PROTECTION (SCMS)" on this page.)

Can't edit!

Edit operations are not possible.

Can't REC!

Recording is not possible. The loaded disc may be protected or there may not be enough blank space remaining on the disc.

Can't REC

Recording is not possible. The loaded disc may be damaged.

DIG in Unlock

No digital signal is being input to the selected digital input jack.

TMP Over!!

The temperature of the unit has exceeded the normal operating temperature. Turn off the unit and let it cool down. If the unit is installed in a place with little ventilation (such as a built in bookcase), move the unit to another location with better ventilation.

Disc Full

Recording is not possible because there is no blank space remaining on the disc.

Title Full!

Additional characters cannot be input for the current title because the maximum number of characters for a single title (250) has already been input.

UTOOC W Error

Error occurred when writing to the UTOC.

Not Audio

The inserted disc is not an audio MD.

Tr Protected

The selected track cannot be edited because it is protected.

TOC Full

The disc area allotted for TOC data has become full and further editing is not possible.

UTOOC Err L0~4

Problem involving UTOC data.

TOC Writing

The TOC data is being written to the disc. Do not move the unit or pull out the mains lead. If you do, recorded material may not be saved normally.

TOC Reading

The unit is reading the TOC data.

Protected

The record protection on the inserted MD is set to "protect".

PlayBack MD

The inserted MD is designed for playback only (you cannot record on this disc).

Monitor Out

The monitor out function is active. The audio signal input to the selected input terminals is output from this unit's output terminals.

No Track

Blank disc is played or searched.

COPY PROTECTION (SCMS)

As a digital audio component, this MD recorder conforms with the Serial Copy Management System (SCMS) standards. The Serial Copy Management System restricts copies made by recording digital signals to first-generation copies only. Therefore, an MD recorded through a digital input cannot be used as a source for making another digital recording.

Care of MDs

- Do not expose the MD to direct sunlight or heat sources such as hot air ducts, nor leave it in a car parked in direct sunlight as there can be a considerable rise in temperature inside the car.
- Periodically remove dust and debris from the cartridge surface by wiping it with a dry cloth.
- Because the MD itself is housed in a cartridge, you can handle it normally without being concerned about dirt or fingerprints. However, malfunctioning may result if the cartridge itself is dirty or warped.

Do not open the shutter on the MD cartridge

Trying to force the shutter open will damage the shutter.

TROUBLESHOOTING

If your MD recorder fails to operate normally, check the following table. It lists common operating errors and simple measures which you can take to correct the problem. If it cannot be corrected, or the symptom is not listed, disconnect the recorder's power cord and contact your authorized YAMAHA dealer or service center for help.

Symptom	Cause	Remedy
The unit does not respond to operations.	<ul style="list-style-type: none"> • MD is dirty or damaged. • MD is damaged ("UTOC Err L0~4" appears in the display). 	<ul style="list-style-type: none"> • Replace the current disc with a new one.
It happens that this unit does not work normally.	<ul style="list-style-type: none"> • There is an influence of strong external noise (lightning, excessive static electricity, etc.) or a misoperation was performed while using this unit. 	<ul style="list-style-type: none"> • Turn the power off and disconnect the AC power from the AC outlet. After about 30 seconds have passed, connect the power and try again.
Playback is not possible.	<ul style="list-style-type: none"> • Moisture is on the laser pickup. • The power is OFF. • The disc has been loaded incorrectly. • An unrecorded (blank) MD was loaded ("Blank Disc" appears in the display). 	<ul style="list-style-type: none"> • Leave the unit switched ON and wait 20 to 30 minutes for the moisture to evaporate before trying to play a disc. • Press STANDBY/ON (POWER on the remote) to turn the power on. • Reload the disc with the label side facing up, and the arrow pointing toward the disc insertion slot. • Insert a recorded MD.
Recording is not possible.	<ul style="list-style-type: none"> • The disc is write protected ("Protected" appears in the display). • A pre-mastered MD is loaded ("Playback MD" appears in the display). • The source is not connected correctly. • The input setting is incorrect. • The recording level is too low. • The digital output level of the digital source is too low. • There is not enough blank space left on the MD. • If the power cord was unplugged or there was a power outage during recording, that recording may be lost. 	<ul style="list-style-type: none"> • Slide the write-protect tab to the closed position. • Load a recordable MD. • Check all connections again. • Press INPUT repeatedly to select the correct input jacks. • Turn REC LEVEL to adjust the recording level. • Set the digital output level of the digital source to "MAX". • Load a recordable MD with fewer recorded tracks, or erase unnecessary tracks from the current MD. • If recording was interrupted, try recording again starting from the beginning.
The MD cannot be removed when partially inserted.	<ul style="list-style-type: none"> • The carriage lock function has activated. 	<ul style="list-style-type: none"> • Insert the MD completely, then press  to eject it.
Excessive noise.	<ul style="list-style-type: none"> • The unit is too close to the television or other component. 	<ul style="list-style-type: none"> • Place the unit farther away from the television or other component.
The remote control does not operate.	<ul style="list-style-type: none"> • The batteries are exhausted. • The remote control transmitter is operated from an incorrect distance or angle. • The remote control sensor is located in strong direct light. 	<ul style="list-style-type: none"> • Replace the batteries. • Operate the remote from less than 6 meters (about 20 feet) and within 30° on either side of the sensor. • Place the unit away from the strong light.

SPECIFICATIONS

Digital audio system

System

MiniDisc digital audio system

Laser

Semiconductor laser

Laser Diode Properties

Material: GaAlAs

Wavelength: 785 nm

Pulse time:

Read mode ... 0.6 mW Continuous

Write mode ... max 10 mW 0.5S
min cycle 1.5S

Repetition

Record/Playback Time

Max. 74 minutes (using MDW-74 disc)

74 minutes (stereo)

148 minutes (mono)

Sampling Frequency

44.1 kHz (32 kHz and 48 kHz signals converted to

44.1 kHz for recording)

Frequency Response

5 – 20,000 Hz ± 0.5 dB

Signal-to-Noise Ratio

More than 99 dB during playback

Digital Rec Level

Min. – +12 dB

Inputs

LINE IN (REC)

Type: pin jack

Standard input level (50 k-ohms): 300 mV

DIGITAL IN (OPTICAL) (2)

Type: square optical connector jack

Outputs

LINE OUT (REC)

Type: pin jack

Standard output level (1 kHz, 0 dB): 2.0 ± 0.5 Vrms

DIGITAL OUT (OPTICAL)

Type: square optical connector jack

General

Power Supplies

230 V, 50 Hz (U.K. and Europe models)

110/120/220/240 V, 50/60 Hz (General model)

240 V, 50 Hz (Australia model)

Power Consumption

16 W

Dimensions (W x H x D)

217 x 88 x 298 mm (8-9/16" x 3-7/16" x 11-3/4")

Weight

3.0 kg (6 lbs. 10 oz.)

Accessories

Remote control x1

RCA pin cables x2

Optical fiber cable x1

System control cable x1

Batteries (size AA, R6, UM-3) x2

Specifications subject to change without notice.

- **CAUTION**

Use the minidisc recorder only in accordance with the instructions given in this manual and do not attempt to interfere with the interlock switch or make any other adjustments as this may result in exposure to hazardous radiation.

- **VORSICHT**

Verwenden Sie den Mini-Disc Recorder nur entsprechend den in dieser Anleitung angegebenen Anweisungen, und versuchen Sie nicht, den Verriegelungsschalter zu beeinträchtigen, oder machen Sie keine andere Einstellung, da dies dazu führen kann, gefährlicher Ausstrahlung ausgesetzt zu werden.

- **ATTENTION**

Utiliser le lecteur-enregistreur minidisc en respectant les indications données dans ce manuel et éviter l'intervention sur le commutateur de verrouillage ou tout autre réglage. En cas de non-respect, on s'exposera à une radiation dangereuse.

- **PRECAUCIÓN**

Utilice el grabador/reproductor minidisc sólo de acuerdo con las instrucciones dadas en este manual y no intente interferir el interruptor de bloqueo ni realizar ningún otro ajuste porque podría ocasionar la exposición a radiación peligrosa.

- **OBSERVERA**

Använd den miniskivinspelaren endast i enlighet med anvisningarna i denna bruksanvisning och försök inte påverka låsningsströmbrytaren eller göra andra inställningar som kan leda till risk för farlig strålning.

- **ATTENZIONE**

Quando si usa il registratore de minidisc, seguire le istruzioni di questo. Non cercare di interferire con l'interruttore interbloccato e non effettuare altre regolazioni, poiché ciò potrebbe provocare un'esposizione a pericolose radiazioni.

- **LET OP**

Gebruik deze MiniDisc-recorder alleen zoals in de aanwijzingen in deze gebruiksaanwijzing staat vermeld. Maak geen veranderingen in de interlockschakelaar of andere onderdelen, daar dit mogelijk blootstelling aan gevaarlijke stralingen veroorzaakt.

Klassmärkning för Finland

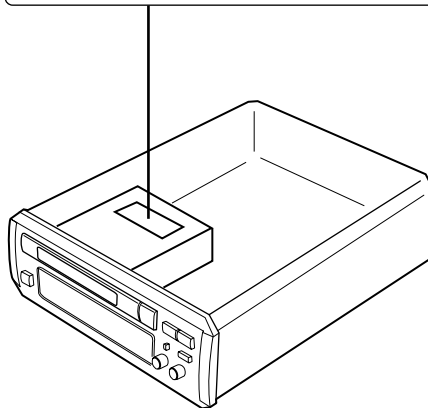
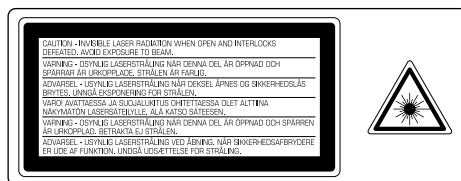
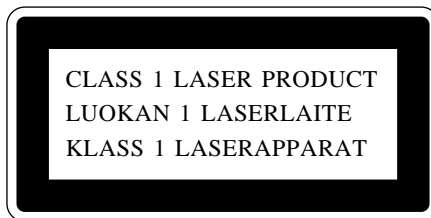

VAROITUS! LAITTEEN KÄYTTÄMINEN MUULLA KUIN TÄSSÄ KÄYTTÖOHJEESSA MAINITULLA TAVALLA SAATTA AALTISTAA KÄYTTÄJÄN TURVALLISUUSLUOKAN 1 YLITTÄVÄLLE NÄKYMÄTTÖMÄLLE LASERSÄTEILYLLE.

VARNING - OM APPARATEN ANVÄNDS PÅ ANNAT SÄTT ÄN I DENNA BRUKSANVISNING SPECIFICERAS. KAN ANVÄNDAREN UTSÄTTAS FÖR OSYNLIG LASERSTRÅLNING, SOM ÖVERSKRIDER GRÄNSEN FÖR LASERKLASS 1.

YAMAHA ELECTRONICS CORPORATION, USA 6660 ORANGETHORPE AVE., BUENA PARK, CALIF. 90620, U.S.A.

YAMAHA CANADA MUSIC LTD. 135 MILNER AVE., SCARBOROUGH, ONTARIO M1S 3R1, CANADA

YAMAHA ELECTRONIK EUROPA G.m.b.H. SIEMENSSTR. 22-34, 25462 RELLINGEN, BEI HAMBURG, F.R. OF GERMANY

YAMAHA ELECTRONIQUE FRANCE S.A. RUE AMBROISE CROIZAT BP70 CROISSY-BEAUBOURG 77312 MARNE-LA-VALLEE CEDEX02, FRANCE

YAMAHA ELECTRONICS (UK) LTD. YAMAHA HOUSE, 200 RICKMANSWORTH ROAD WATFORD, HERTS WD1 7JS, ENGLAND

YAMAHA SCANDINAVIA A.B. J A WETTERGRENS GATA 1, BOX 30053, 400 43 VASTRA FRÖLUNDA, SWEDEN

YAMAHA MUSIC AUSTRALIA PTY, LTD. 17-33 MARKET ST., SOUTH MELBOURNE, 3205 VIC., AUSTRALIA

YAMAHA CORPORATION

Printed in Malaysia  V423680